

PROFINET-INspektor[®] NT

User Manual



Diagnostic and service tools for PROFINET / Ethernet

Revision overview

Date	Revision	Change(s)
10/09/2015	0	First version
04/07/2016	1	Firmware Update 1.4
22/12/2016	2	Firmware Update 1.5

© Copyright 2016 Indu-Sol GmbH

We reserve the right to amend this document without notice. We continuously work on further developing our products. We reserve the right to make changes to the scope of supply in terms of form, features and technology. No claims can be derived from the specifications, illustrations or descriptions in this documentation. Any kind of reproduction, subsequent editing or translation of this document, as well as excerpts from it, requires the written consent of Indu-Sol GmbH. All rights under copyright law are expressly reserved for Indu-Sol GmbH.

Caution!

This device may only be put into operation and operated by qualified personnel. Qualified personnel, as referred to in the safety-related information of this manual, are persons who are authorised to put into operation, to earth and to label devices, systems and electrical circuits in accordance with the standards of safety engineering.

Contents

1	General information	6
1.1	Purpose of use	6
1.2	Scope of supply	7
1.3	Safety information	7
2	Device ports and status indicators	8
2.1	Device ports	8
3	Installation	9
3.1	Installation instructions	9
3.2	Voltage supply	10
3.3	Measurement location	10
3.4	Connection to the PROFINET network	10
3.4.1	Fixed installation within the master system	10
3.4.2	Connection via feedback-free measurement point	11
3.5	WEB INTERFACE	11
3.6	Signal inputs and outputs	12
3.7	Display screen	12
4	Web interface and selection functions	13
4.1	Homepage	14
4.1.1	Alarm overview	15
4.1.2	Timeline	15
4.1.3	Network overview	16
4.1.4	Node overview	16
4.1.5	Network statistics	18
4.2	Alarms	19
4.3	Evaluation	20
4.3.1	Netload chart	20
4.3.2	Reports	20
4.3.3	Jitter overview	21
4.3.4	Node statistic	21
4.3.5	Frame statistic	22
4.3.6	Tools	22
4.4	Configuration	23
4.4.1	System	23
4.4.1.1	General	24
4.4.1.2	Time and language settings	24

4.4.1.3	Network	25
4.4.1.4	Messages	25
4.4.1.5	Digital Input	26
4.4.1.6	Factory reset	27
4.4.1.7	Import/Export	27
4.4.1.8	Information	28
4.4.2	Monitoring	29
4.4.2.1	Node names and monitoring	29
4.4.2.2	Node condition	30
4.4.2.3	Triggers & alarms	32
4.4.2.4	Automated report	35
4.4.2.5	Control mode	35
4.4.3	Firmware update	36
5	Device parameters	37
5.1	Update rate	37
5.2	Alarm (high priority / low priority)	37
5.3	Bus node failures	37
5.4	Bus node restart	37
5.5	Jitter	37
5.6	Telegram gaps	38
5.7	Telegram overtakes	38
5.8	Error telegrams	38
5.9	Netload	38
5.10	Multicast telegrams	38
5.11	Broadcast telegrams	38
5.12	Sending cycle	38
6	Support and contact	39
7	Sample for controlling the PN-INspektor® NT	40
7.1	TiA-Portal Program example	41
8	Block diagram	42
9	Technical data	43
9.1	Technical drawing	43

1 General information

Please read this document thoroughly from start to finish before you begin installing the device and putting it into operation.

1.1 Purpose of use

The PROFINET-INspektor® NT permanently monitors all data traffic in a PROFINET master system. You will receive a maintenance requirement notification when critical changes that could lead to unplanned system downtimes are detected.

Based on the report analysis (purely passive behaviour), the following quality parameters are monitored:

- Update rate
- Error telegrams (sent/received)
- Alarms (low and high-priority)
- Telegram gaps
- Telegram overtakes
- Bus node failure
- Bus node restart
- Jitter
- Netload (sent/received)

One PN-INspektor® NT is required per PROFINET master system. This PN-INspektor is looped into the connection between the IO controller (PLC) and the first device (switch) for analysis, or integrated within the network through a feedback-free measurement point (e.g. PNMA II; art. no. 114090100).

No additional IP addresses or adjustments to the PLC program are required for using the PN-INspektor® NT. It works in an entirely manufacturer-independent way; i.e. the analysis works completely independently of the type of control system and IO devices.

For long-term analysis, the PN-INspektor® NT can remain in the bus system without any time restrictions. The relevant telegram traffic is continuously analysed and evaluated in order to detect deviations from normal conditions and trigger alarms.

1.2 Scope of supply

The scope of supply comprises the following individual parts:

- PROFINET-INspektor® NT
- 3-pole plug-in terminal block (power supply)
- 6-pole plug-in terminal block (alarm contacts)
- CD with software for the report analysis and device manual

Please check the contents are complete before putting into operation.

1.3 Safety information

- Never open the housing of the PROFINET-INspektor® NT
- Opening the housing immediately voids any warranty
- If you think the device is defective, send it back to the supplier

2 Device ports and status indicators

2.1 Device ports

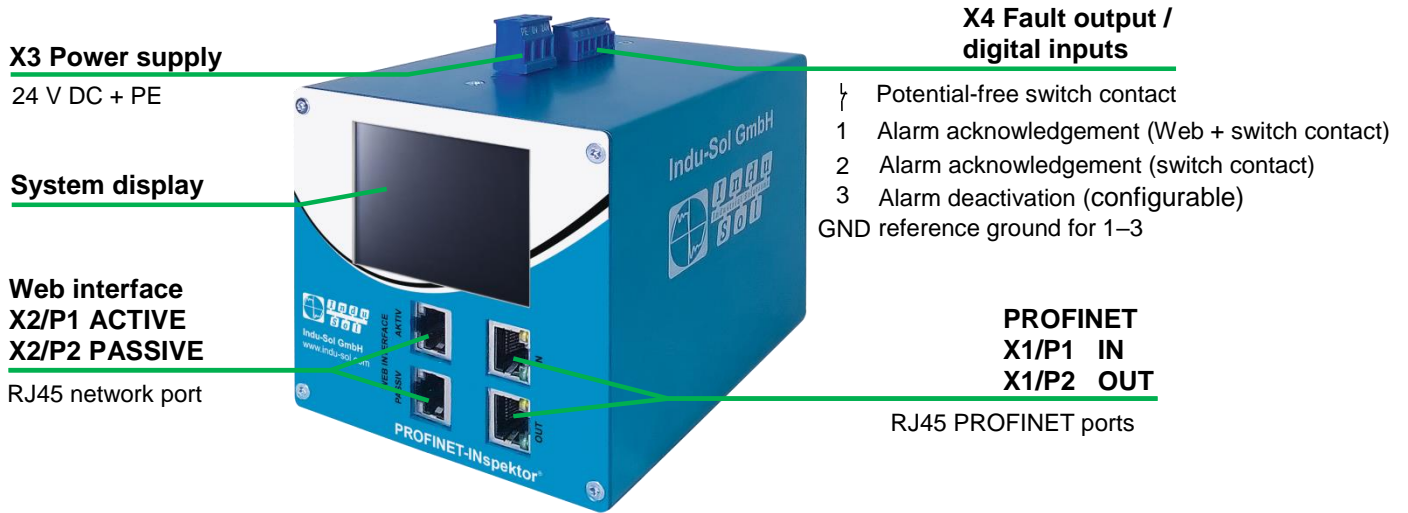

Figure 1: Device ports

3 Installation

3.1 Installation instructions

PROFINET-INspektor® NT is installed horizontally inside the cabinet on a 35 mm top-hat rail in accordance with DIN EN 60715.



Figure 2: Device installation on top-hat rail

Caution: The following distances must be maintained from other modules for correct installation:

- From left and right: 20 mm
- From top and bottom: 50 mm

Removal for alternate use of the PN-INspektor® NT in different master systems is illustrated in Figure 3.



Figure 3: Removal

3.2 Voltage supply

Operation requires 24 V of external direct current, which is to be connected to the device via the 3-pole plug-in terminal block (X3) supplied in the package. The PE contact should be connected to the local PE system.

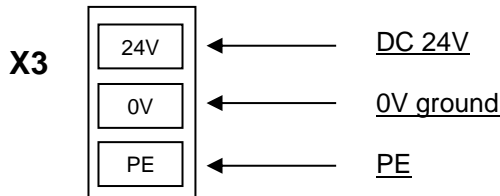

Caution: When connecting, make sure that the polarity is correct.

3.3 Measurement location

Wherever possible, the PN-INspektor® NT should always be installed in the network connection between the PLC and the first I/O device or switch, since the majority of communication typically takes place via this connection.

3.4 Connection to the PROFINET network

You can connect to the PROFINET network in different ways. The various options are described below.

3.4.1 Fixed installation within the master system

The PROFINET-INspektor® NT is firmly integrated into the network for continuous, permanent network analysis. To do this the device is integrated into the system via the IN and OUT sockets.

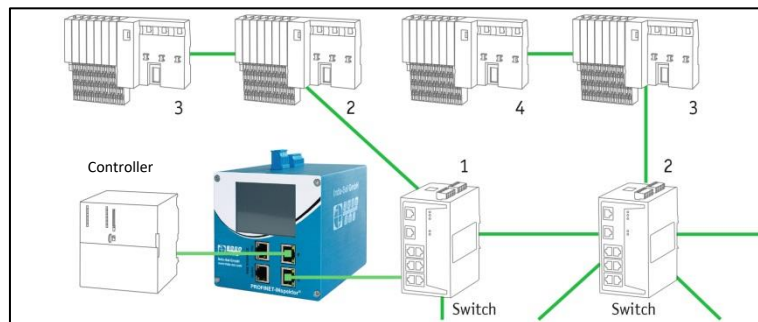

Figure 4: PROFINET-INspektor® NT fixed installation



Caution: Installing the device with this connection option causes a PROFINET network fault and should be performed during system standstill.

3.4.2 Connection via feedback-free measurement point

In conjunction with a feedback-free measurement point (e.g. PNMA II; art. no. 114090100), PROFINET-INspektor® NT can be connected to the PROFINET-system at any time without compromising ongoing system operation. This can also be performed on a temporary basis if required. To do this, the PN-INspektor® NT is hooked up to the M1 and M2 monitor sockets of the measurement point by means of two patch cables.

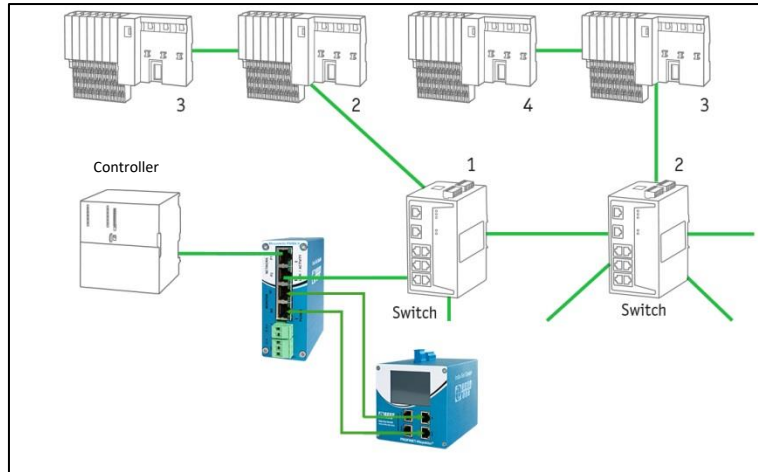

Figure 5: PN-INspektor® NT connection via PNMA II

3.5 WEB INTERFACE

The LAN connections X2/P1 and X2/P2 of the WEB INTERFACE constitute the link to the PN-INspektor® NT. This involves 10Base-T/1000Base-T RJ45 interfaces. A standard Ethernet cable is used as a connection cable to a PC/ laptop (not included in the scope of supply).

A Web-server function is integrated for access to the device and can be opened with an appropriate standard browser (e.g. Microsoft Internet Explorer from version 10 or Mozilla Firefox from version 11; JavaScript must be activated). You can reach the device's user interface by entering the IP address of the PN-INspektor® NT in the browser's command line.



Caution: To display the website correctly, the following ports must be enabled in firewalls, gateways and routers: TCP/80 and TCP/6325.

The PROFINET-INspektor® NT is supplied with the following factory-set network configuration:

	PASSIVE – X2/P2	ACTIVE – X2/P1
IP address:	192.168.212.212	192.168.213.212
Subnet mask:	255.255.255.0	255.255.255.0

Both the evaluation of internally recorded data and the parametrisation of the device are possible through the **PASSIVE** and **ACTIVE** connection sockets. These are two independent network access. Additional to the web access the active Webinterface can send requests to the PROFINET Network. For this it is necessary to start a "Device scan" in the Device overview. This is used to retrieve and store information such as the name, IP address, etc. for the respective device.

3.6 Signal inputs and outputs

The 6-pole connector terminal block (X4) at the top of the device is assigned as follows:

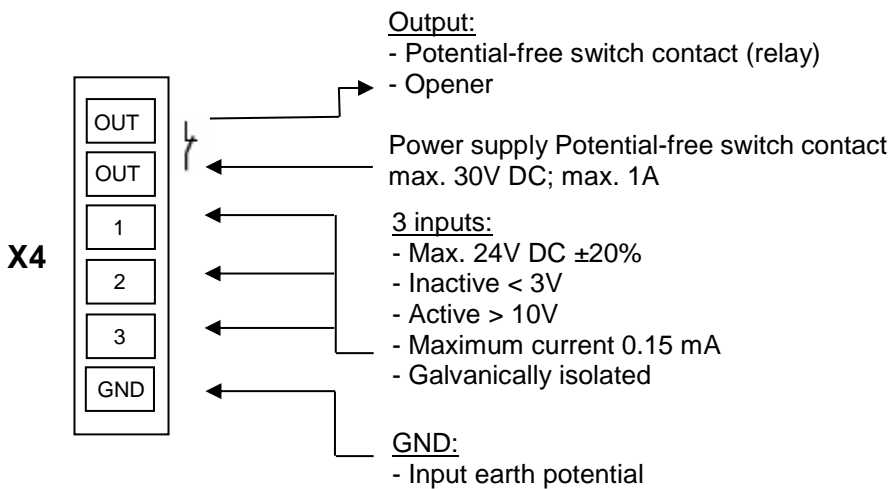

Input 1: Alarm acknowledgement (Web interface + switch contact)

Input 2: Alarm acknowledgement (switch contact)

Input 3: Alarm deactivation

Additional functions can be configured via the Web interface (see point [4.4.1.5. Digital Input](#))

3.7 Display screen

After connecting the power supply, the display conveys the system start-up of the PN-INspektor® NT. After successful system start-up, the current state of the PROFINET network is always displayed on the Home screen. You can scroll between the menu items with the arrow keys on both sides. The Home key takes you directly to the Home screen.

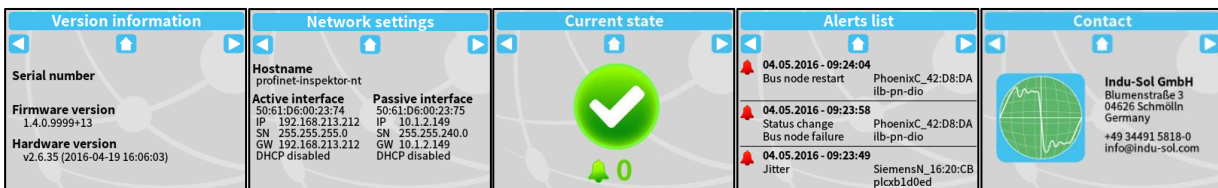

Figure 6: Touch-Screen menu

4 Web interface and selection functions

To access the Web interface, and thus the recorded data of the PROFINET-INspektor® NT, use an Internet browser and enter the IP address (passive: 192.168.212.212; active: 192.168.213.212) of the device to open the Web interface.

The following icons are used in the Web interface for a simple overview of the individual statuses of the network and devices:



No faults: PROFINET communication is working without any problems.



Warning: A communication fault or a diagnostic message has appeared in the network, or originated from a device, and this fault or message has not yet led to system failure. The sources of these events should be localised and resolved.



Fault: A critical fault has appeared in the network, or originated from a device, and this fault leads to system failure. It is urgently necessary to resolve the fault.



The bus communication in the network has failed or cannot be detected by the INspektor (serious fault in the network) or the device is no longer communicating or is not in the network.

4.1 Homepage

The homepage provides a complete overview of the status of the connected PROFINET master system since the start of the PN-INspektor® NT.

If there are no faulty entries here, the system is working stably and there are no urgent actions required.

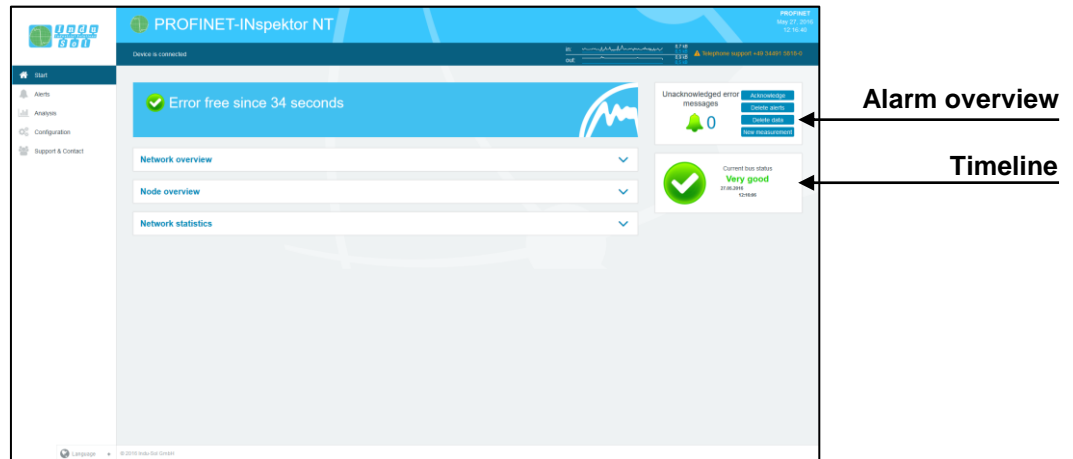

Figure 7: Complete overview

There are additional helpful functions for obtaining more detailed information on the state of the network. These can be accessed via drop-down menus or the Alarm Overview.

Specifying the time period, with a corresponding display of device information, is possible in the sub-menus of the homepage. The relevant period of evaluation can be selected by switching the time window between “current”, “last minute” and “history”. The “current” setting always displays the node condition (live list) at that particular moment, and the “last minute” option shows the device information over the course of the previous minute. With the “history” pre-selection, all data is displayed since the beginning of the recording or the last time the “Delete data” or “New measurement” function was commanded. You can use these different time references to determine whether PROFINET faults are occurring occasionally or permanently.

4.1.1 Alarm overview

In the alarm overview the number of unacknowledged alarms are indicated to you. The entries in the alarm list are opened automatically with a mouse click on the alarm bell.

You can also perform the following functions in this window:

Acknowledge alarms: Unacknowledged alarms are acknowledged, but the entries stay in the alarm list. The switch contact for the alarm is reset.

Delete alarms: All entries in the alarm list, including snapshots for this, are deleted.

Delete data: All previously recorded data is reset and the network analysis is restarted. The device information (IP address, PN name) and configured settings are retained.

New measurement: This item is to be applied in the event of alternating use in different PROFINET systems. By selecting this function, all previous entries including the node list are deleted, and the network analysis is restarted. Any configuration settings made are retained.

4.1.2 Timeline

The timeline offers you a compact visual overview of the state of the network over the course of time. If different network statuses are analysed within the course of the monitoring period, the point in time when the respective status change started is presented as a new node (maximum 50 entries). Detailed information accumulated within this time frame can be accessed by selecting one such node. The minimum time period for a status change (new nodes) is one minute.

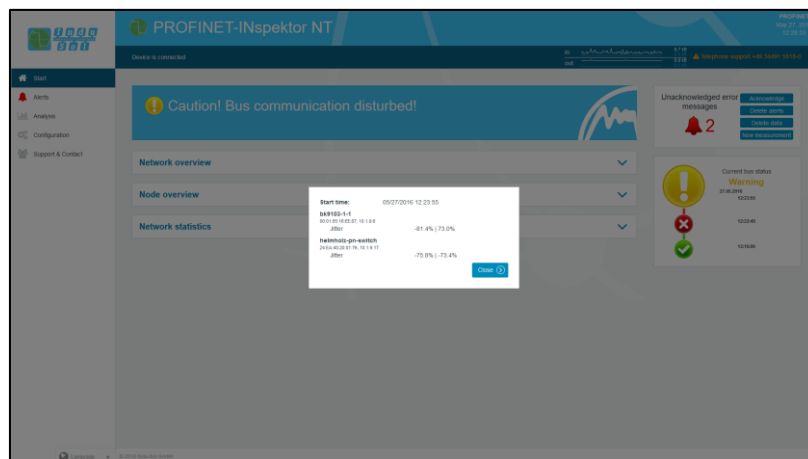

Figure 8: Timeline entry



The individual status changes can be adjusted for each node separately. (See point [4.4.2.2 Node condition.](#))

4.1.3 Network overview

You obtain a complete overview of all the important quality parameters of the PROFINET master system through the “Network overview” selection window. These form the basis for evaluating a network’s stability. The individual parameters are explained in more detail in point [5. Device parameters](#). To make it easier to evaluate the quality parameters, they can be coloured according to predefined acceptance values. (see point [4.4.2.5 Control mode](#))

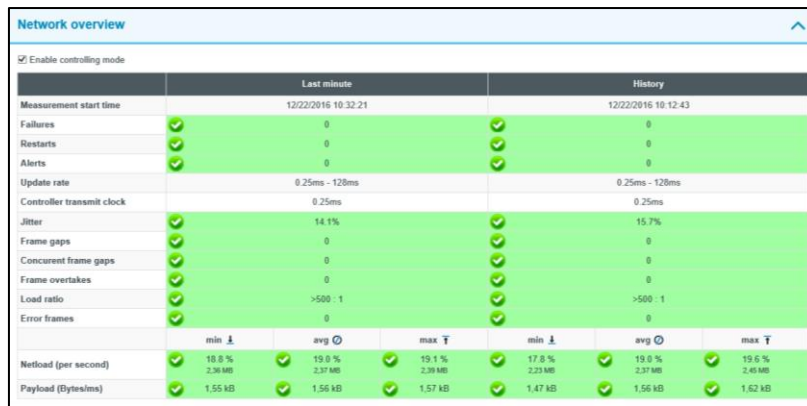

	Last minute			History		
Measurement start time	12/22/2016 10:32:21			12/22/2016 10:12:43		
Failures	0	0	0	0	0	0
Restarts	0	0	0	0	0	0
Alerts	0	0	0	0	0	0
Update rate	0.25ms - 128ms			0.25ms - 128ms		
Controller transmit clock	0.25ms			0.25ms		
Jitter	14.1%	14.1%	14.1%	15.7%	15.7%	15.7%
Frame gaps	0	0	0	0	0	0
Concurrent frame gaps	0	0	0	0	0	0
Frame overtakes	0	0	0	0	0	0
Load ratio	>500 : 1			>500 : 1		
Error frames	0	0	0	0	0	0
	min ↓	avg ○	max ↑	min ↓	avg ○	max ↑
Netload (per second)	10.0 % 2.36 MB	19.0 % 2.37 MB	19.1 % 2.39 MB	17.8 % 2.23 MB	19.0 % 2.37 MB	19.6 % 2.45 MB
Payload (Bytes/ms)	1.55 kB	1.56 kB	1.57 kB	1.47 kB	1.56 kB	1.62 kB

Figure 9: “Network overview” selection window

4.1.4 Node overview

This overview provides you with a complete outline of all devices communicating within the PROFINET network. The individual devices are marked in different colours based on node condition and communication protocol (PROFINET or acyclical communication). The meaning of the respective statuses is explained in the legend at the top.

For greater clarity, you can select the displaying of different types of protocol and individual evaluation criteria. To display all configured device Information (PN-Name, IP-Adresse), it is possible to start a device scan to retrieve the information (see section [3.5 WEB INTERFACE](#)).

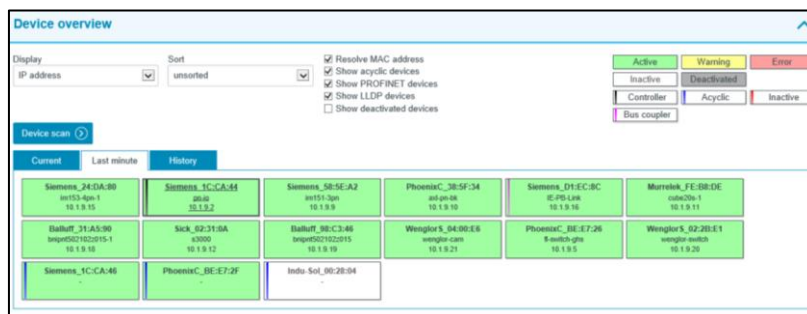

Device overview

Display: IP address | Sort: unsorted

Resolve MAC address
 Show acyclic devices
 Show PROFINET devices
 Show LLDP devices
 Show deactivated devices

Active Warning Error
Inactive Deactivated
Controller Acyclic Inactive
Bus coupler

Current	Last minute	History			
Siemens_24-DA-90 10.1.9.15	Siemens_1C-CA-44 10.1.9.12	Siemens_58-SE-A2 10.1.9.9	PhoenixC_38-SF-34 10.1.9.10	Siemens_D1-EC-8C 10.1.9.16	Murrelek_FE-8B-DE 10.1.9.11
Balluff_31-A5-99 10.1.9.18	Sick_52-31-8A 10.1.9.12	Balluff_38-C3-46 10.1.9.19	Wenglor_04-00-E6 10.1.9.21	PhoenixC_BE-E7-26 10.1.9.5	Wenglor_02-20-E1 10.1.9.20
Siemens_1C-CA-46	PhoenixC_BE-E7-2F	Indu-Sol_00-20-04			

Figure 10: “Node overview” selection window

For a detailed view of device information, select the relevant device with a mouse click. The essential data for evaluating the communication quality of this node is then displayed

General						
MAC address	Siemens_1C:CA:44					
IP address	10.1.9.2					
Name	pn-io					
Alias						
Vendor	S7-300					
Vendor ID	SIEMENS AG (42)					
Device ID	257					
Device role	Controller					
	Last minute			History		
Alert (low priority)	✓	0	✓	0		
Alert (high priority)	✓	0	✓	0		
Failures	✓	0	✓	0		
Restarts	✓	0	✓	0		
Frame gaps	✓	0	✓	0		
Concurrent frame gaps	✓	0	✓	0		
Frame overtakes	✓	0	✓	0		
Error frames	✓	0	✓	0		
Jitter	✓	4.8%	✓	9.6%		
	min	avg	max	min	avg	max
Update rate	0.25ms	-	2ms	0.25ms	-	128ms
Transmit clock	0.25ms	-	0.25ms	0.25ms	-	0.25ms
Measured update rate	0.24ms	19.66ms	128.00ms	0.23ms	19.65ms	128.01ms
Payload (sent)	737,90 B	764,35 B	776,83 B	457,69 B	764,35 B	776,83 B
Payload (received)	772,67 B	800,39 B	813,53 B	493,94 B	800,39 B	813,53 B
Netload (sent per sec)	9.02% 1,13 MB	9.35% 1,17 MB	9.50% 1,19 MB	5.56% 694,41 kB	9.35% 1,17 MB	9.50% 1,19 MB
Netload (received per sec)	✓9.30% 1,16 MB	✓9.63% 1,20 MB	✓9.79% 1,22 MB	✓5.84% 730,51 kB	✓9.63% 1,20 MB	✓9.79% 1,22 MB

Figure 11: Detailed information window

As a sub-item to the detailed information, additional, more detailed **device-related** data is listed through the “Network statistic” page.

	Last minute	History
Load ratio	>500 : 1	>500 : 1
Broadcasts (of these PROFINET)	0 (0 0%)	0 (0 0%)
Multicasts (of these PROFINET)	24 (0 0.00%)	798 (0 0.00%)
Frames (sent) (of these PROFINET)	752.345 (752.343 100.00%)	25.023.838 (25.023.836 100.00%)
Frames (received) (of these PROFINET)	753.696 (753.696 100.00%)	25.068.810 (25.068.810 100.00%)
Bytes (sent) (of these PROFINET)	51,16 MB (51,16 MB 100.00%)	1,70 GB (1,70 GB 100.00%)
Bytes (received) (of these PROFINET)	50,84 MB (50,84 MB 100.00%)	1,69 GB (1,69 GB 100.00%)
Error frames (sent) (of these PROFINET)	0 (0 0%)	0 (0 0%)
Error frames (received) (of these PROFINET)	0 (0 0%)	0 (0 0%)
Payload (sent)	33,10 MB	1,10 GB
Payload (received)	32,75 MB	1,09 GB

Figure 12: Device-related network statistics

4.1.5 Network statistics

Further detailed information on the **whole** PROFINET network is displayed below the “Network statistics” selection window.

Network statistics		
	Last minute	History
Broadcasts <small>(of these PROFINET)</small>	0 <small>(0 0.0%)</small>	1 <small>(0 0.00%)</small>
Multicasts <small>(of these PROFINET)</small>	98 <small>(0 0.00%)</small>	5,023 <small>(0 0.00%)</small>
Frames (sent) <small>(of these PROFINET)</small>	1,506,054 <small>(1,506,044 100.00%)</small>	77,201,967 <small>(77,201,348 100.00%)</small>
Frames (received) <small>(of these PROFINET)</small>	1,506,056 <small>(1,506,045 100.00%)</small>	77,201,969 <small>(77,201,348 100.00%)</small>
Bytes (sent) <small>(of these PROFINET)</small>	102,01 MB <small>(101,99 MB 99.99%)</small>	5,23 GB <small>(5,23 GB 99.99%)</small>
Bytes (received) <small>(of these PROFINET)</small>	102,00 MB <small>(101,99 MB 100.00%)</small>	5,23 GB <small>(5,23 GB 100.00%)</small>
Payload (sent)	65,85 MB	3,38 GB
Payload (received)	65,85 MB	3,38 GB

Figure 13: Whole system network statistics

4.2 Alarms

This overview represents a list of all alarm entries since the restart or the resetting of alarms through the “Delete alarms”, “Delete data” or “New measurement” commands. All unacknowledged entries are indicated with the  icon. The maximum quantity of saved alarms is 2,048. Any additional entries over that overwrite the oldest entries.

An entry is automatically made in the alarm list, including a telegram record (snapshot), when a triggering event occurs. Such an entry will contain all important information, such as the device address, fault event and time. In addition to an entry in the alarm overview, the value for unacknowledged alarms increases by one. The saved snapshots can be downloaded by pressing the disc icon and opened with the “Wireshark” software (this software is included in the scope of supply).

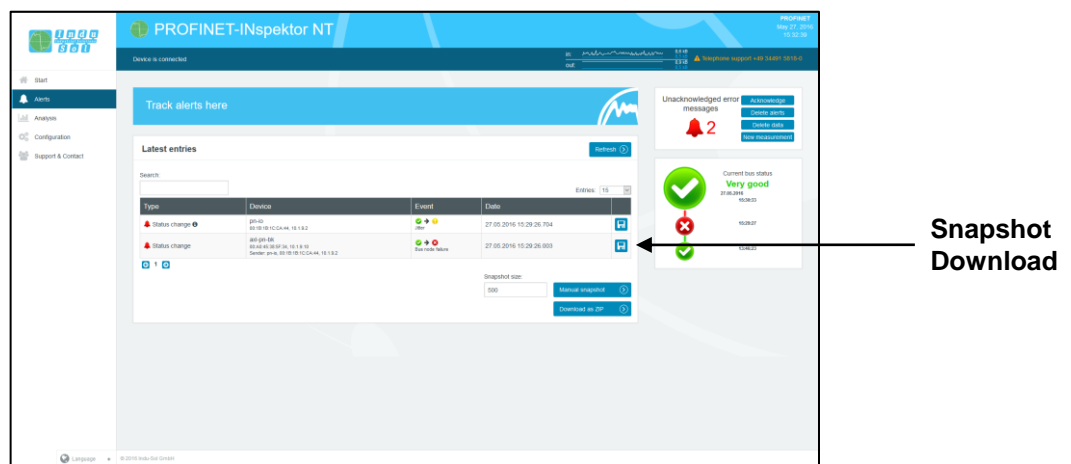

Figure 14: Alarms

The following functions are also available to you in this menu:

- Update:** Updates the entries in the alarm list
- Manual snapshot:** Records the current telegram traffic, which is also stored as an entry in the alarm list.
- Download as ZIP:** You can download all snapshots and a currently created log as a ZIP archive through this option.

4.3 Evaluation

The evaluation menu contains the “Netload chart” and the “Report function”.

4.3.1 Netload chart

In the chart function, this sub-menu provides a quick visual overview of the netload performance of the communication route. Here data is distinguished between incoming and outgoing netloads and presented in second and minute-cycles.

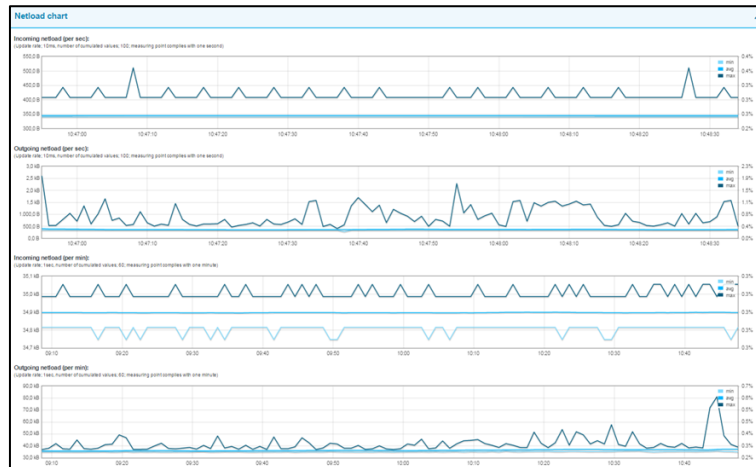

Figure 15: Netload charts

4.3.2 Reports

The report function allows for all information gathered since the beginning of the recording to be documented in a report in summary form. These reports are stored in the report directory and can be exported from here or printed out. The reports can be used for one’s own documentation or as an acceptance report.

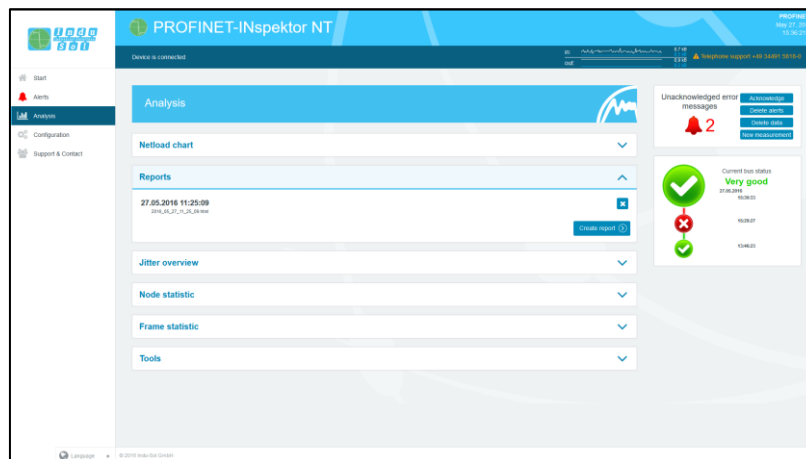

Figure 16: Reports



For the complete topology to be shown in the log printout, the "Print Background" function must be activated in printer settings.

The report function can also be used for the automated creation of reports (see section [4.4.2.4 Automated report](#)).

4.3.3 Jitter overview

For each update rate that was set in the PROFINET network, the jitter overview displays the corresponding jitter values that were detected, including global values and device-specific values. At a glance, you can see the update rates and devices that have increased jitter values.

To display the values, you can choose between table view and graphic view.

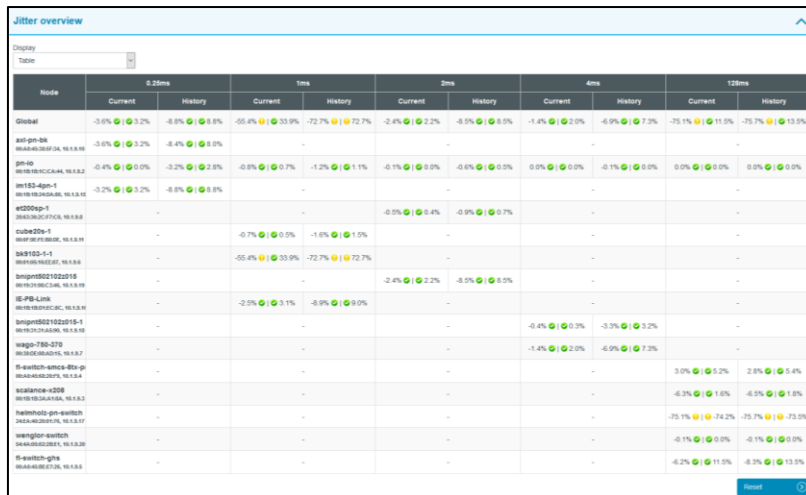

Node	0.25ms		1ms		2ms		4ms		128ms											
	Current	History	Current	History	Current	History	Current	History	Current	History										
Global	-3.0%	3.2%	-8.0%	3.0%	-55.4%	33.0%	-72.7%	72.7%	-2.4%	0.2%	-8.3%	0.3%	-1.4%	0.2%	-6.9%	7.3%	-73.1%	11.5%	-73.7%	13.2%
all-pn-04 HMI1400504, 16.1.8.16	-3.6%	3.2%	-8.4%	0.5%	-	-	-	-	-	-	-	-	-	-	-	-	-	-	-	-
pn-10 HMI1400504, 16.1.8.16	-0.4%	0.0%	-3.2%	2.0%	-0.8%	0.7%	-1.2%	1.1%	-0.1%	0.0%	-0.8%	0.3%	0.0%	0.0%	-0.1%	0.0%	0.0%	0.0%	0.0%	0.0%
hmi15-4gn-1 HMI1400504, 16.1.8.16	-0.2%	0.1%	-8.0%	0.0%	-	-	-	-	-	-	-	-	-	-	-	-	-	-	-	-
h200ap-1 HMI1400504, 16.1.8.16	-	-	-	-	-0.0%	0.4%	-0.9%	0.7%	-	-	-	-	-	-	-	-	-	-	-	-
cube20s-1 HMI1400504, 16.1.8.16	-	-	-0.7%	0.5%	-1.6%	1.5%	-	-	-	-	-	-	-	-	-	-	-	-	-	-
hsk100-1-1 HMI1400504, 16.1.8.16	-	-	-55.4%	33.0%	-72.7%	72.7%	-	-	-	-	-	-	-	-	-	-	-	-	-	-
lmpm102102015 HMI1400504, 16.1.8.16	-	-	-	-	-2.4%	0.2%	-0.5%	0.3%	-	-	-	-	-	-	-	-	-	-	-	-
IP-Link HMI1400504, 16.1.8.16	-	-	-2.5%	1.1%	-8.9%	0.0%	-	-	-	-	-	-	-	-	-	-	-	-	-	-
lmpm102102015-1 HMI1400504, 16.1.8.16	-	-	-	-	-	-	-2.4%	0.2%	-3.3%	0.3%	-	-	-	-	-	-	-	-	-	-
wago-750-270 HMI1400504, 16.1.8.7	-	-	-	-	-	-	-	-	-1.4%	0.2%	-4.9%	7.3%	-	-	-	-	-	-	-	-
FSwitch-ams2-80-gp HMI1400504, 16.1.8.4	-	-	-	-	-	-	-	-	-	-	-	-	-	-	-	-	-	-	-	-
scas10m-1008 HMI1400504, 16.1.8.3	-	-	-	-	-	-	-	-	-	-	-	-	-	-	-	-	-	-	-	-
hmi1400504-gp-switch HMI1400504, 16.1.8.17	-	-	-	-	-	-	-	-	-	-	-	-	-	-	-	-	-	-	-	-
wanglor-switch HMI1400504, 16.1.8.20	-	-	-	-	-	-	-	-	-	-	-	-	-	-	-	-	-	-	-	-
FSwitch-gp1 HMI1400504, 16.1.8.6	-	-	-	-	-	-	-	-	-	-	-	-	-	-	-	-	-	-	-	-

Figure 17: Jitter overview

4.3.4 Node statistic

This sub-menu offers a statistics function for individual PROFINET quality parameters through all analysed network devices. Through this option you can see the device-related accumulation for the selected parameter at a glance.

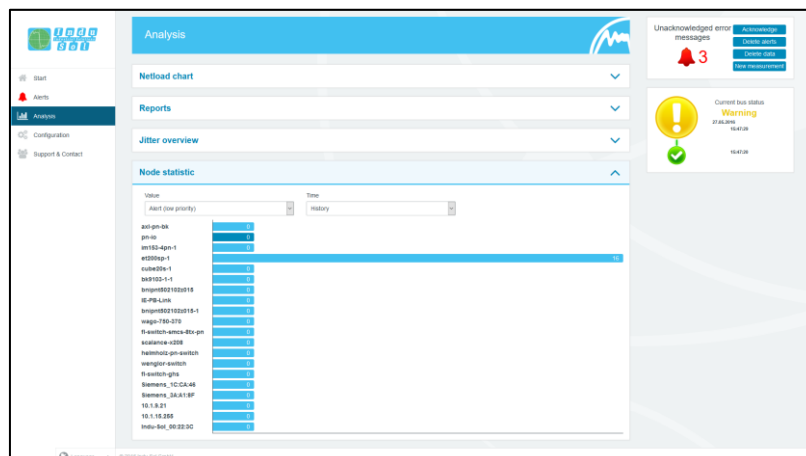

Figure 18: Node statistic

4.3.5 Frame statistic

Under the point Telegram Statistics, the number of telegrams is grouped according to the various log types, and is displayed graphically. With this graphic you can easily see which log type has a negative influence on the load ratio.



Figure 19: Frame statistic

4.3.6 Tools

Under Tools, you can perform a ping and a traceroute to a specific IP address.

- Ping: Check for accessibility of IP address
- Traceroute: Determination of quantity and IP address of network transitions between the inspector and the specified IP address

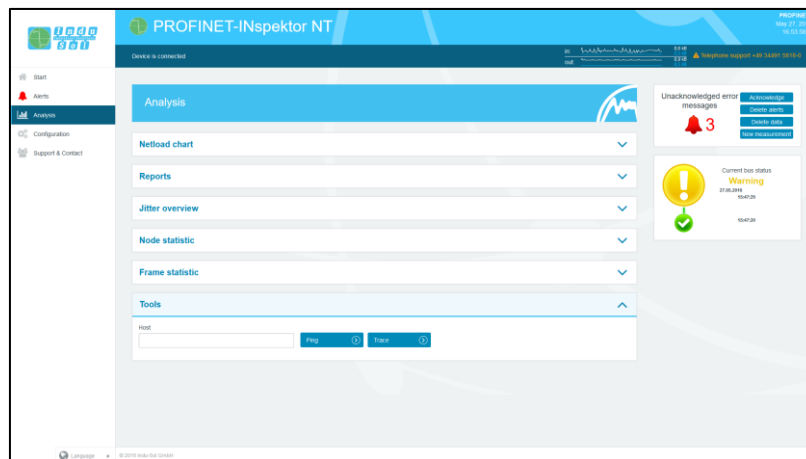

Figure 20: Tools

4.4 Configuration

Within the configuration menu, you can make changes to the general device settings of the PN-INspektor® NT and adapt the monitoring function specifically to your PROFINET network.



All entries are saved in the device by pressing the **“Adopt”** button or reset to the default setting through **“Reset” + “Adopt”**.

The functions are described individually below.

4.4.1 System

Basic device settings, such as date / time, device name, IP address, etc., are displayed in the system settings and can be changed here. The entries are kept in the event of power failure or device modification.

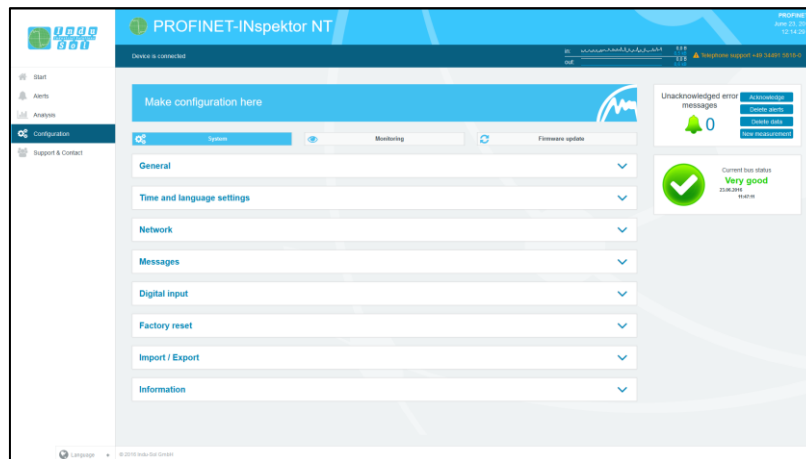

Figure 21: System settings – complete overview

4.4.1.1 General

In this sub-menu, entries can be made for device name, installation location, network name and notes that provide a more detailed description of the device and the network to be monitored. In addition to these entries, this menu allows setting up a password for the INspektor®. This password will then be required for all changes made to device and monitoring settings.

Furthermore, deactivating and calibrating the display is possible in this window.

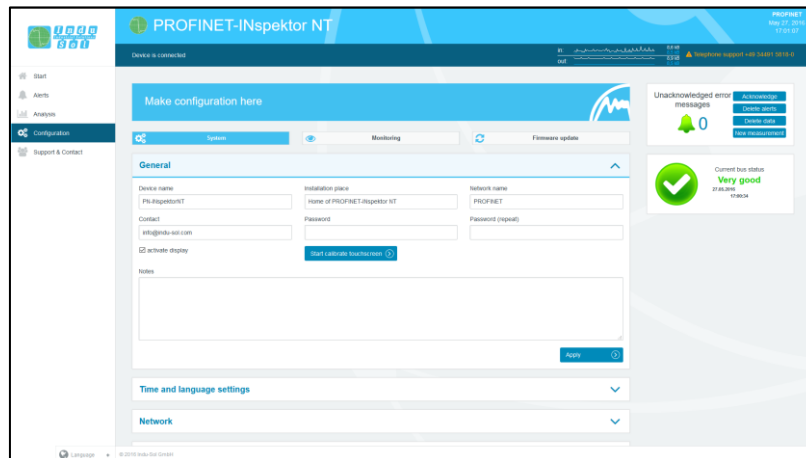

Figure 22: System settings – general

4.4.1.2 Time and language settings

In this menu, settings are made for the system time and for the default language of the PN-INspektor® NT. The system time can either be entered manually, be adopted automatically from local PC system time, or be retrieved from a time server.

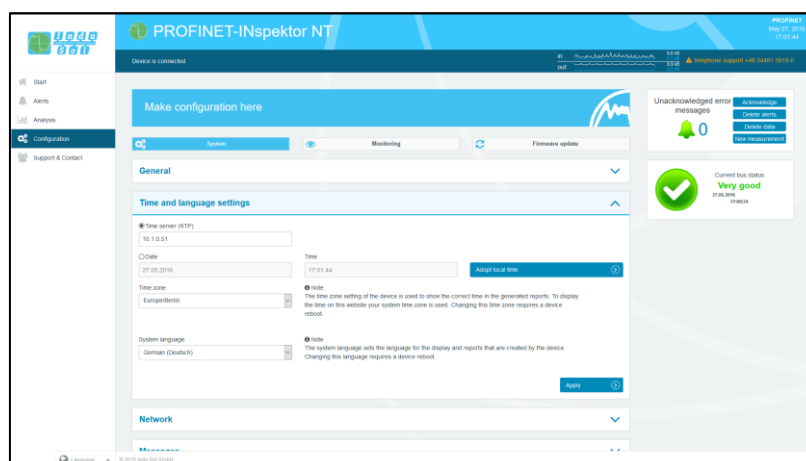

Figure 23: Time and language settings



In order for the time to be displayed correctly in the log, you must always specify the time zone, both if the time is entered manually and if it is retrieved automatically.

4.4.1.3 Network

Under this item the network address settings are defined for both the “ACTIVE” and “PASSIVE” network connections of the PN-INspektor® NT (e.g. address, subnet mask, gateway). In this process, you can decide whether you want to use a fixed address or if the IP address should be obtained automatically (DHCP).

In addition, the current status of the interfaces (connected / not connected) is displayed.

The configuration of a mirror port is also possible in this menu. The function allows telegrams that are recorded to the diagnostic ports (IN / OUT) to be forwarded to the active or passive web interface. This function is deactivated by default after each boot of the device.

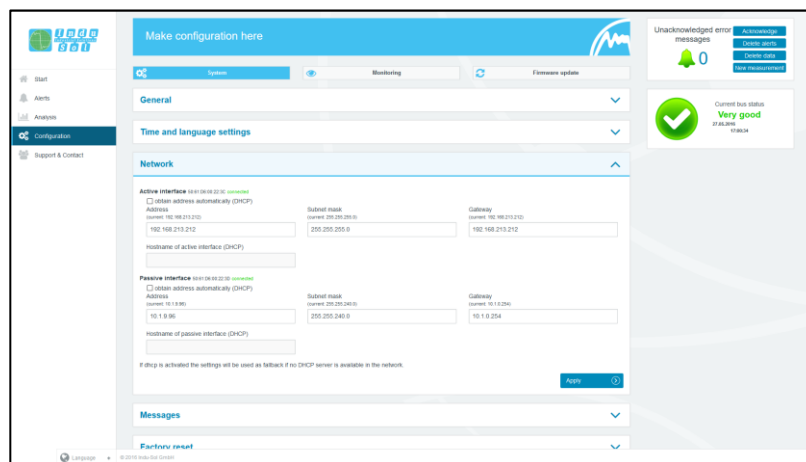

Figure 24: Network settings



To ensure error-free access to the Web interface, addresses from different address ranges or subnets must be assigned to both network connections

4.4.1.4 Messages

With the message function, it is possible to arrange the sending of an email through the PN-INspektor® NT in the event of an alarm. To do this you require a valid recipient address, the IP address of the email server resp. SNMP trap host and an Ethernet connection between the device and the server.

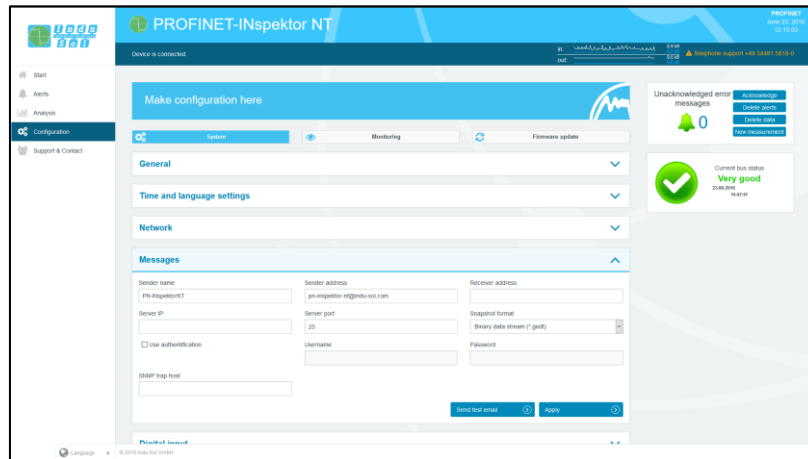

Figure 25: "Messages" selection window



For email alerts, it is imperative that the "Email" action has been activated for the desired trigger condition (see section [4.4.2.3 Triggers & Alarms](#)).

4.4.1.5 Digital Input

For configuration of the digital inputs, you can choose between the following actions under this point. You can enter either a specific or an arbitrary slope change, and multiple actions per input.

- Disable alerts
- Delete data
- New measurement
- Creat report
- Acknowledge alerts
- Reset digital output
- Disable diagnosis

A delay of the recording start can be set via the item „Measurement start delay“. This makes it possible to eliminate the start-up process from the monitoring function in the case of a slowly starting system.

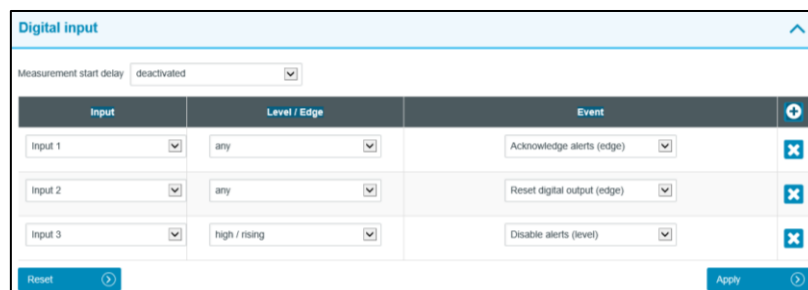

Figure 26: Digital Input

4.4.1.6 Factory reset

Here you can reset the PN-INspektor® NT to default settings. You have the option to retain the network settings, or to reset them as well. After the reset, the device is available again immediately.

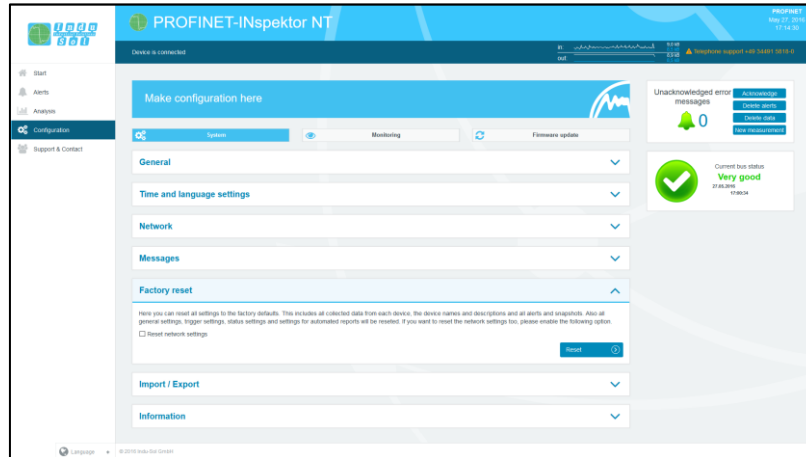

Figure 27: Factory reset



In a reset to default settings, all previously made settings and records are lost.

4.4.1.7 Import/Export

By means of the Import/Export function, all settings that have been made, e.g. general device settings and changes to PROFINET monitoring, can be saved, and loaded again into a PN-INspektor® NT whenever required.

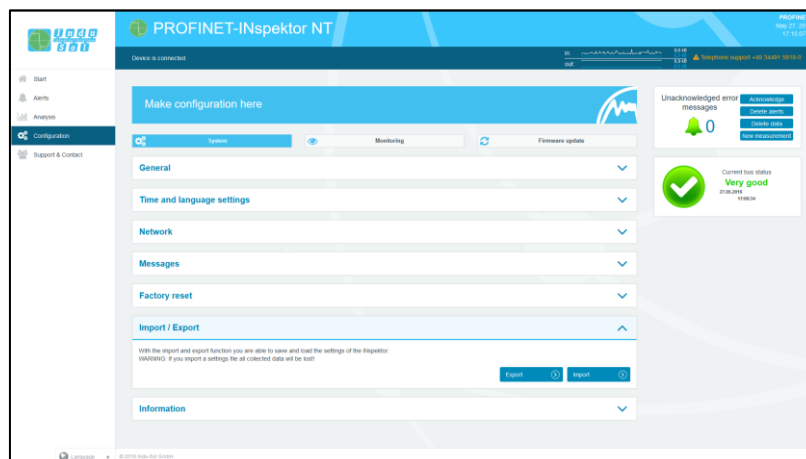

Figure 28: Import/Export

4.4.1.8 Information

Current resource usage and the firmware and hardware versions of the PN-INspektor® NT are displayed in the information overview.

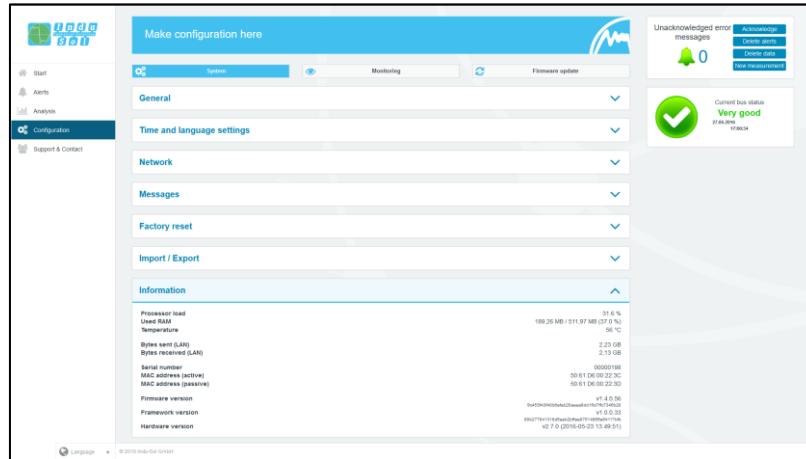

Figure 29: PN-INspektor® NT device information

4.4.2 Monitoring

You can specifically adjust the monitoring function of the PN-INspektor® NT to your network, define customised trigger and alarm thresholds and set up automated reporting with the specifications in these fields.

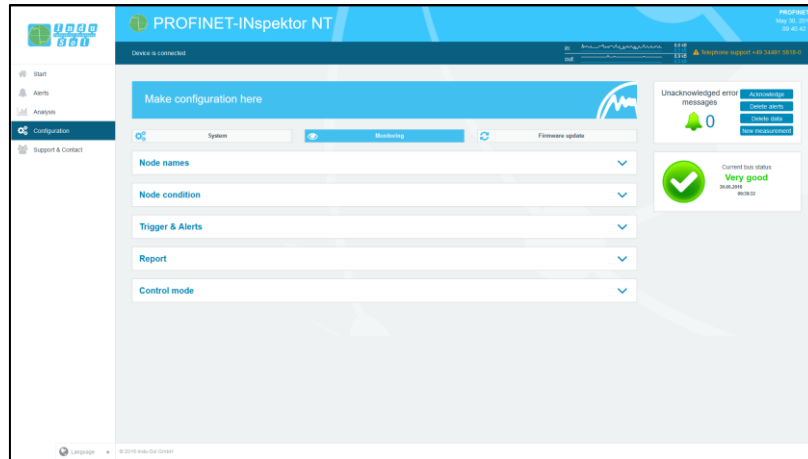

Figure 30: Monitoring – complete overview

4.4.2.1 Node names and monitoring

The point "Node names and monitoring" allows to assign an alias name to each device. It is therefore possible, for example, to adopt and to save the device model, equipment identifier or installation location from the electrical diagrams. All entries will be visible throughout the entire system.

In addition, this menu allows to deactivate monitoring for individual or newly detected devices or limited the analysis to the device, which communicate exclusively with the corresponding station.

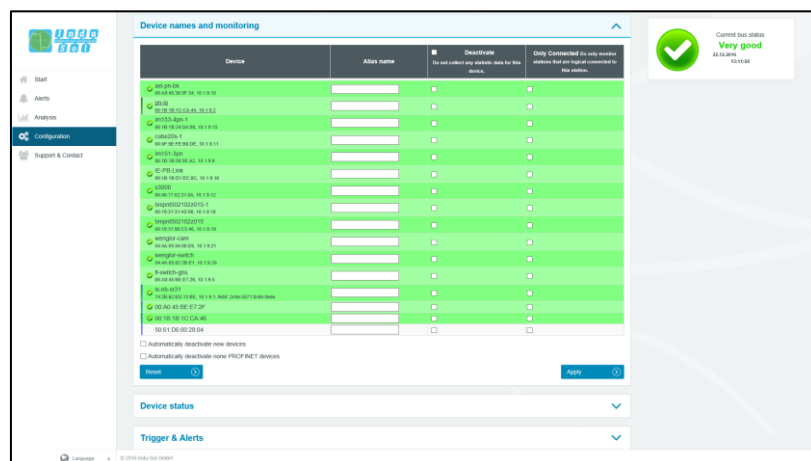





Figure 31: overview node names

4.4.2.2 Node condition

It is possible to make adjustments to the display of node conditions over the entire master system (globally) and to specific nodes in this sub-menu. In this process, a node may adopt the following conditions, depending on the fault event and setting:

-  No fault
-  Warning
-  Fault

In the default setting, the PN-INspektor® NT is programmed so that alarms, error telegrams, increased jitter, telegram gaps, telegram overtakes and an increased netload of any node lead to “Warning” status; and failures lead to “Fault” status.

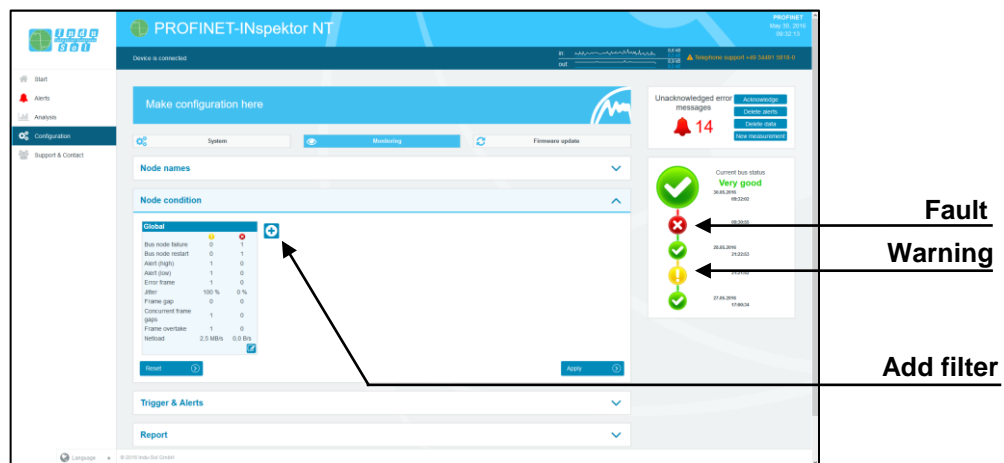

Figure 32: Node condition – default setting

By adding and editing additional event fields, the node conditions can be customised. In this process, node-specific settings overwrite global values. This means it is possible to create node-specific settings to hide fault events which are justified in normal system operation.

Example: The system operator must enter a light barrier for a part change. This results in a device alarm (low) which is irrelevant to bus status evaluation. By deselecting the alarm (low) function of the nodes concerned in the PN-INspektor® NT, these stay “green” in the display.

As can be seen in the following illustration, in this example the “Telegram gap” event was deselected for the controller and the status change for the ET200SP was fully deactivated.

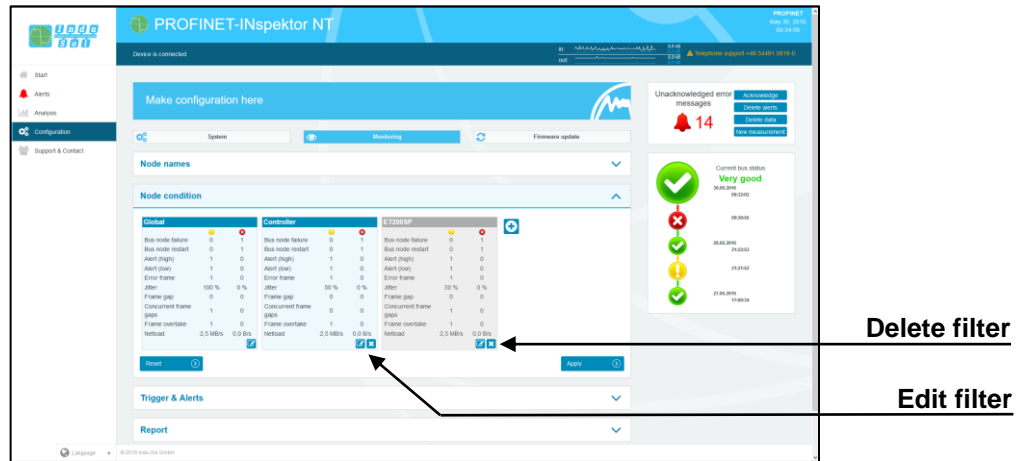

Figure 33: Applying filters

The figure below shows the setting options in the editing window for the controller (telegram gap → 0) as an example.

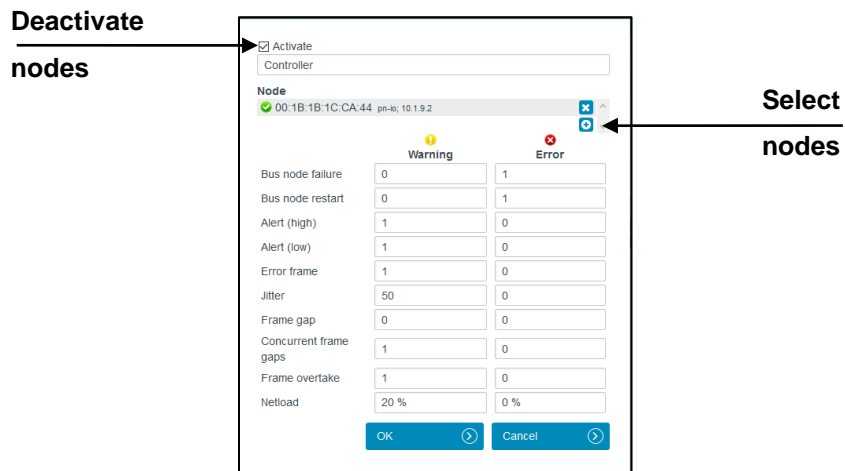

Figure 34: Controller telegram gap deactivated

4.4.2.3 Triggers & alarms

For the configuration of alarms and evaluation through switch contact, snapshot and email, the relevant parameters can be set under the item “Triggers & alarms”.

In the device's default settings, all fault events of any PROFINET node automatically lead to an alarm entry in the status display and timeline, the creation of a fault record (snapshot), the connection of the switch contact and notification via email and SNMP-trap (if configured). The number of telegrams before and after an event can be freely selected between 0 and 2500. This means that the size of the snapshot can be freely selected as required

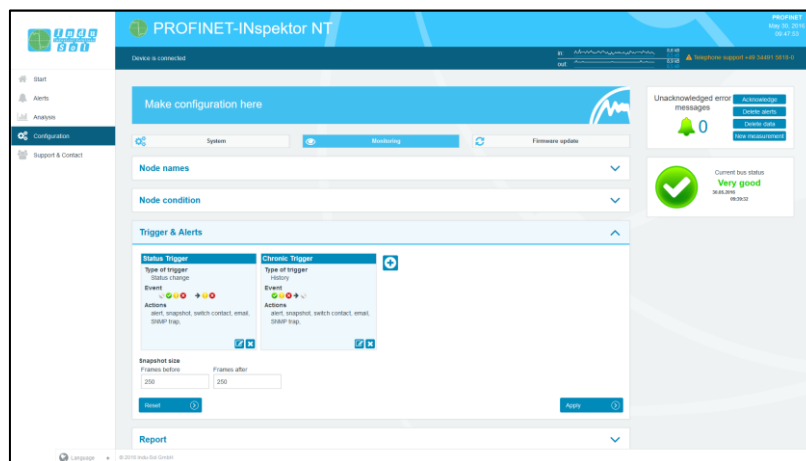

Figure 35: Triggers & alarms – default setting

Through a variable configuration of fault triggers in the form of different trigger types and special node addresses, it is possible to make the relevant adjustments here for a targeted fault search or targeted node monitoring.

The various options for editing individual filters are described in greater detail below.

By selecting the editing mode via the edit icon, the selection menu opens for adjusting the settings.

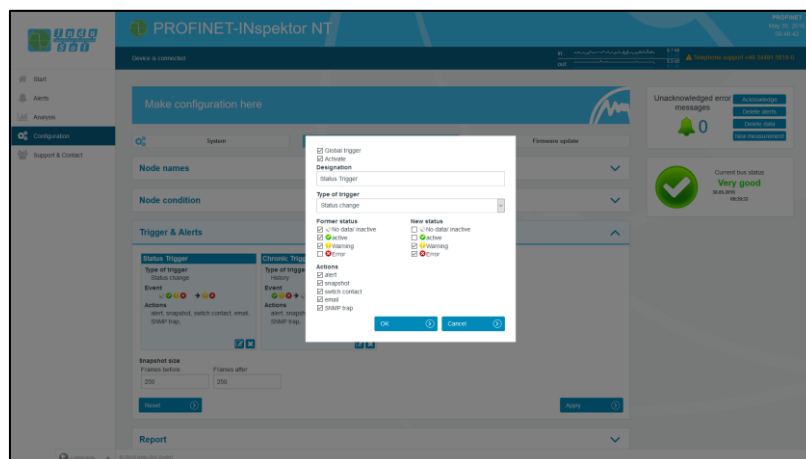

Figure 36: Selection menu for trigger type “status change”

The menu presented in Figure 37 is available for specifying the trigger type.

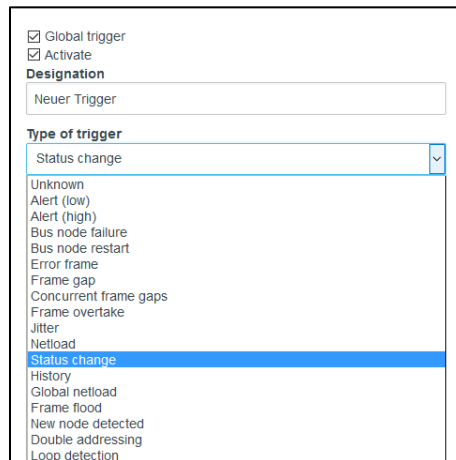

Figure 37: Trigger types

After choosing the individual trigger types (except “Timeline”), there is the option of global monitoring (all nodes) or an address-based selection.

By deselecting the item “Global trigger”, you can select one or more devices from the existing device list via the node menu. The addresses presented are detected independently and system-specifically by the PN-INSpektor® NT.

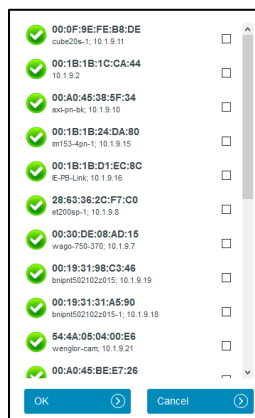

Figure 38: Address list example

The trigger types “Status change” and “Timeline event” each relate to changes in the entries which have been recorded under the item “Node condition” or in the timeline overview.

For threshold-related alarms, the number of **events per second** that should lead to a trigger is specified under this item.

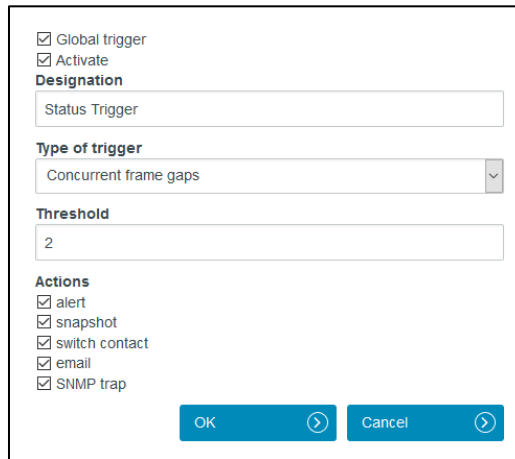

Figure 39: Telegram gap threshold setting

You can make practical use of these setting options to indicate the first signs of deterioration in communication before device failure occurs through an early warning.

The measures for when a trigger event occurs are defined in the options for individual “Actions”.

Example: In PROFINET controllers the maximum number of concurrent frame gaps permitted in the default settings without a system malfunction occurring is 3. In order to receive an early warning promptly at this point and prior to failure, the threshold value is set to 2 concurrent frame gaps in the PN-INspektor® NT. If there are then occasional single gaps in normal operation for process-related reasons, that can be considered perfectly normal. If these frame gaps accumulate to 2 due to ageing, an alarm is triggered by the PN-INspektor® NT; even though the bus system continues to function without device failure. Thanks to this timely warning, you now have time to react before system failure to get to the bottom of the issue.

With the settings in the following example (Figure 39), only the failure of “Drive 0815” causes a trigger. This results in an alert including a snapshot record in PROFINET-INspektor® NT, as well as the activation of the switch contact and the sending of an email notification.

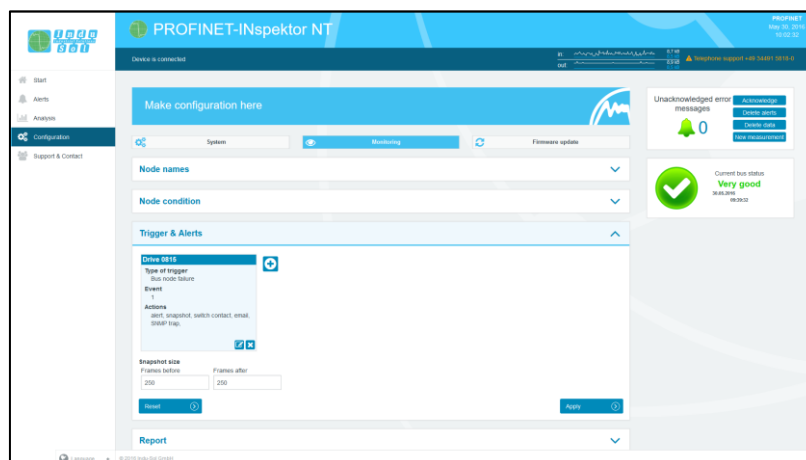

Figure 40: “Drive 0815” failure trigger setting

4.4.2.4 Automated report

The function “Automated report” provides you with the option of documenting the current system status at pre-set time intervals. These reports are then saved in the device regularly and are thus available to you for opening at any time (see item [4.3.2 Reports](#)).

For the completion of the documentation, both the customer data and that of the system inspector can be added. Furthermore, the different sections for report creation can be selected or deselected, and an individual company logo can be used.

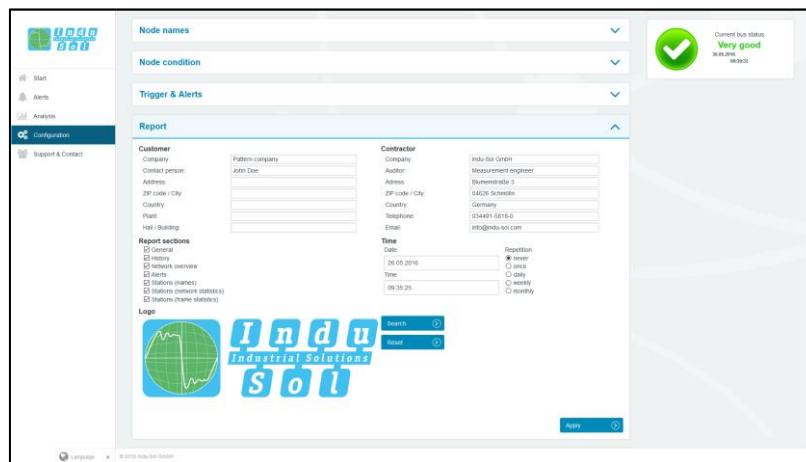

Figure 41: Selection window for automatic report creation

4.4.2.5 Control mode

To allow rapid visual evaluation of the PROFINET network, individual quality parameters can be coloured by entering specific acceptance values. This setting is used both for the website (see point [4.1.3 Network overview](#)) and for the log.

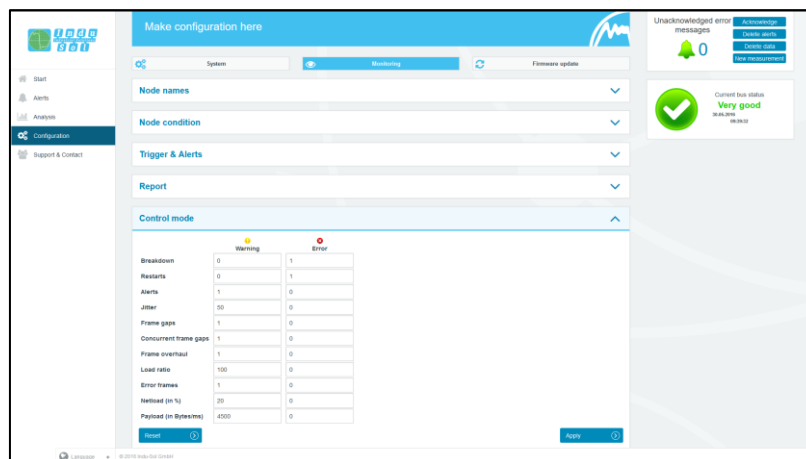

Figure 42: Control mode

4.4.3 Firmware update

You can perform a firmware update for the PN-INspektor® NT using this function, if required. To do this, the new firmware file is selected and uploaded via the “Search” button. Following successful installation, triggering a restart is required in the device with the “Restart” button.

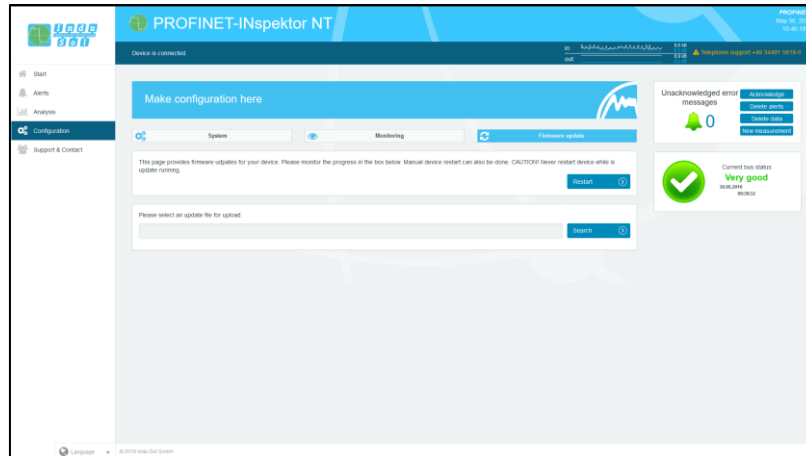

Figure 43: Firmware update

5 Device parameters

5.1 Update rate

The update rate is a fixed value (specific to each device) set in the controller (e.g. 1 ms) indicating the time between data updates in the controller and the I/O device. The decisive criterion for the actual update rate is the netload on the one hand, and the line depth, i.e. the installed network structure and the number of passing devices.

The increasing number of passing devices causes fluctuations in the transit time of telegrams, referred to as “jitter” (see point [5.5 Jitter](#)). By measuring the update rates, it has to be shown that telegram jitter does not exceed half the update rate upwards or downwards (max. 50% jitter).

5.2 Alarm (high priority / low priority)

Diagnostics messages that appear are sent to the PLC as high-priority or low-priority alarms in PROFINET. The event-based division of these alerts (e.g. the shorting of an ET200S module) is defined by each manufacturer themselves for their devices. Unfortunately, a more precise definition is therefore not possible, since the alarms are classified system and node-specifically.

5.3 Bus node failures

In PROFINET node failures are diagnosed by means of the watchdog time of the controller or the node itself. This is determined by the set update time between the controller and node, as well as the number of accepted update cycles with missing I/O data.

If the watchdog time is exceeded, the PN-INspektor® NT reports a failure.

5.4 Bus node restart

The parameter 'Bus device restart' counts all device restarts that occur. A restart of a bus device occurs after a failure or a system start when a bus device has its parameters set by the control system without any faults and then begins the cyclical data exchange.

5.5 Jitter

PROFINET communication is based on maintaining the set update rate of each device with the controller. Positive and negative deviations from this configured update time are referred to as “jitter” in PROFINET.

Jitter of up to 50% of the configured update time is in an acceptable range. Jitter values greater than 50% suggest network performance problems, device issues or an unfavourable layout of the network structure.

5.6 Telegram gaps

A telegram gap in PROFINET means the absence of an update time. Equally, a jitter of 100% may suggest a telegram gap. Telegram gaps are frequently caused by incorrect firmware versions of devices. In such cases the devices do not pass on a telegram or “forget” to send off their own telegram.

5.7 Telegram overtakes

A telegram overtake may arise in PROFINET if peak loads occur in the switch or I/O device. When circumstances are particularly bad, a new telegram may be sent before an old one in the buffer of the switch. Telegram overtakes indicate excessive utilisation or device malfunctions.

5.8 Error telegrams

This entry indicates the number of faulty telegrams detected in the PROFINET-INspektor® NT connection (checksum errors and packet fragments).

5.9 Netload

This includes the netload produced by all reports. This is given as a percentage based on the maximum possible load of a cable at 100 MBit/s. For stable system operation the netload should not exceed 20% in new systems.

5.10 Multicast telegrams

Multicast describes a message transmission from one point to a group and is therefore a form of multipoint connection. There should not be too many of these types of telegram, because they burden the entire network.

5.11 Broadcast telegrams

A broadcast telegram is a message in which data packets are transmitted to all nodes of a communication network from one point. The term “broadcast telegrams” refers to the number of telegrams that have to be received by all nodes.

5.12 Sending cycle

Period between two consecutive intervals for IRT or RT communication. The sending cycle is the shortest possible sending interval for data exchange. The calculated update times are multiples of the sending cycle. We recommend to set the sending cycle to 1 ms.

6 Support and contact

Should you wish to contact us for any reason, further information can be accessed from this page.

You can find the manual stored in the download area as a quick aid.

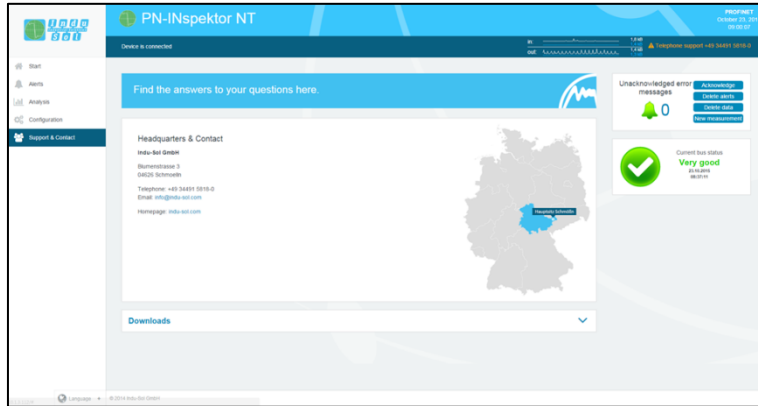
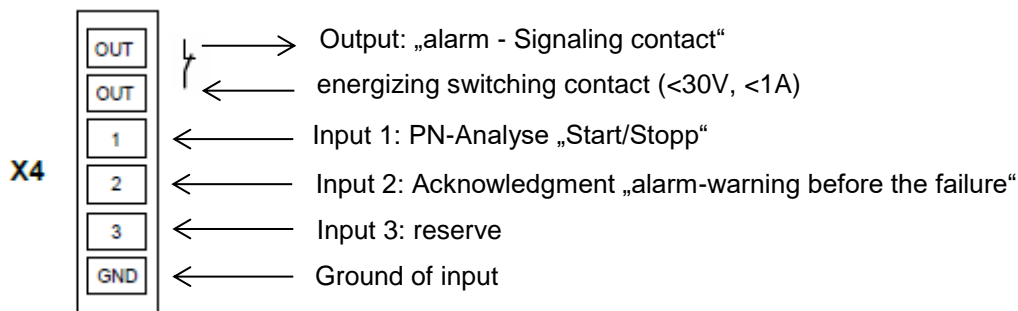

Figure 44: Support and contact

7 Sample for controlling the PN-INspektor® NT



Input 1: PN-Analyse „START / STOPP“

The input 1 is connected to an output of the PLC which outputs a signal from 0 to 1 (> 10V) as a continuous signal when the machine is enabled ("**automatic start-up**"). In the case of "**automatic operating stop**", wanted or unwanted, this enable (continuous signal) must be switched off and is thus set from 1 to 0.

Input 2: Acknowledgment „alarm-warning before the failure“

The input 2 is connected to an output of the PLC and serves to acknowledge the alarm message. This is to be executed as a switching pulse from 0 to 1 (> 10V).

Input 3: Reserve

Output: „alarm – Signaling contact“

The signaling contact is designed as a potential-free break contact. The confirmation is carried out as a function of the thresholds internally set in the PN-INspektor NT. Alarms are signaled from 1 to 0.

Explanation of the target function:

- Scenario 1: Avoiding the alarm when the machine is booted:
The PN-INspektor NT data are deleted when the signal change at input 1 (START / STOP) of the PN-INspektor NT continuous signal from 0 to 1.
At the same time, the alarm input for the switching contact OUT on the PN-INspektor NT is to be enabled during this signal change in the PLC. This means that PROFINET alarms / warnings occurring only from this point in time are displayed on the visualization.
- Scenario 2: PROFINET alarm/warning:
For a PROFINET alarm / warning, the NC (Normally Close) contact "OUT" The input on the PLC is switched from 1 to 0 and thus an alarm / warning for the visualization is output.
If the PROFINET alarm is acknowledged at the visualization, the output at the PLC, which is connected to input 2 (acknowledgment) of the PN-INspektor NT, is to be provided with a switching pulse from 0 to 1. The alarm is acknowledged and the alarm contact is reset to the PN-INspektor NT.

Sample for controlling the PN-INspektor® NT

- Scenario 3: Automatic logging of the PN-INspektor NT:
 In order to obtain a trace of the network state, a protocol is automatically created each time the machine is switched off in the PN-INspektor NT. This is achieved by the use of the signal **AUTOMATIC START / STOP** during the signal change of the duration signal 1 to 0 at input 1 (START / STOP) of the PN-INspektor NT.

7.1 TiA-Portal Program example

Netzwerk 1: Start PROFINET Analyse, High-Pegel on Output A.55
 This message is started when voltage is present, no emergency stop is confirmed, eg automatic mode is active. If all conditions are fulfilled, a high level is present at the output, which goes to the first input of the INspektor.

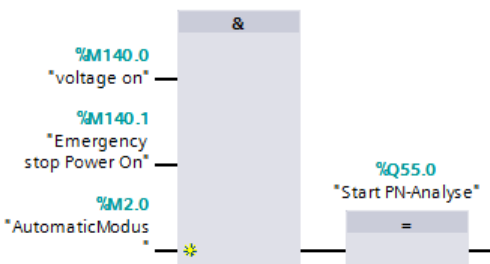

Netzwerk 2: Acknowledgment PROFINET Alarm/Warning
 An alarm can be acknowledged by means of a pushbutton M142, but a high level is applied to input 2 of the INspektor for 3s.

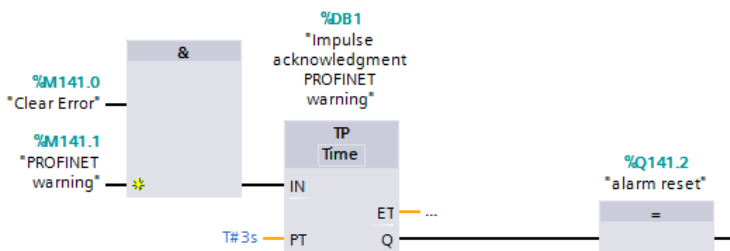

Netzwerk 3: PROFINET Alarm/Warning
 If the PROFINET measurement (network 1) is running and an alarm is present at the output of the INspektor, a PROFINET warning is output on the control panel.

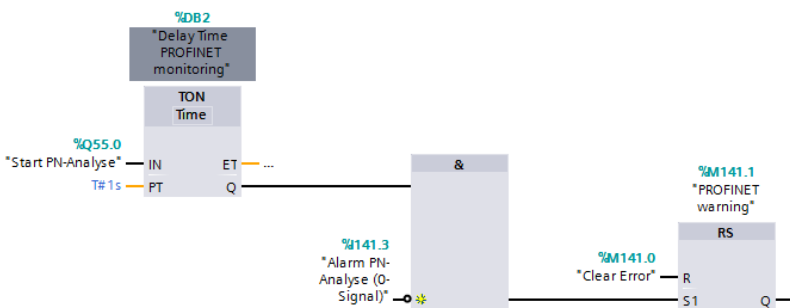

8 Block diagram

The following image is a schematic diagram of the PN-INspektor® NT.

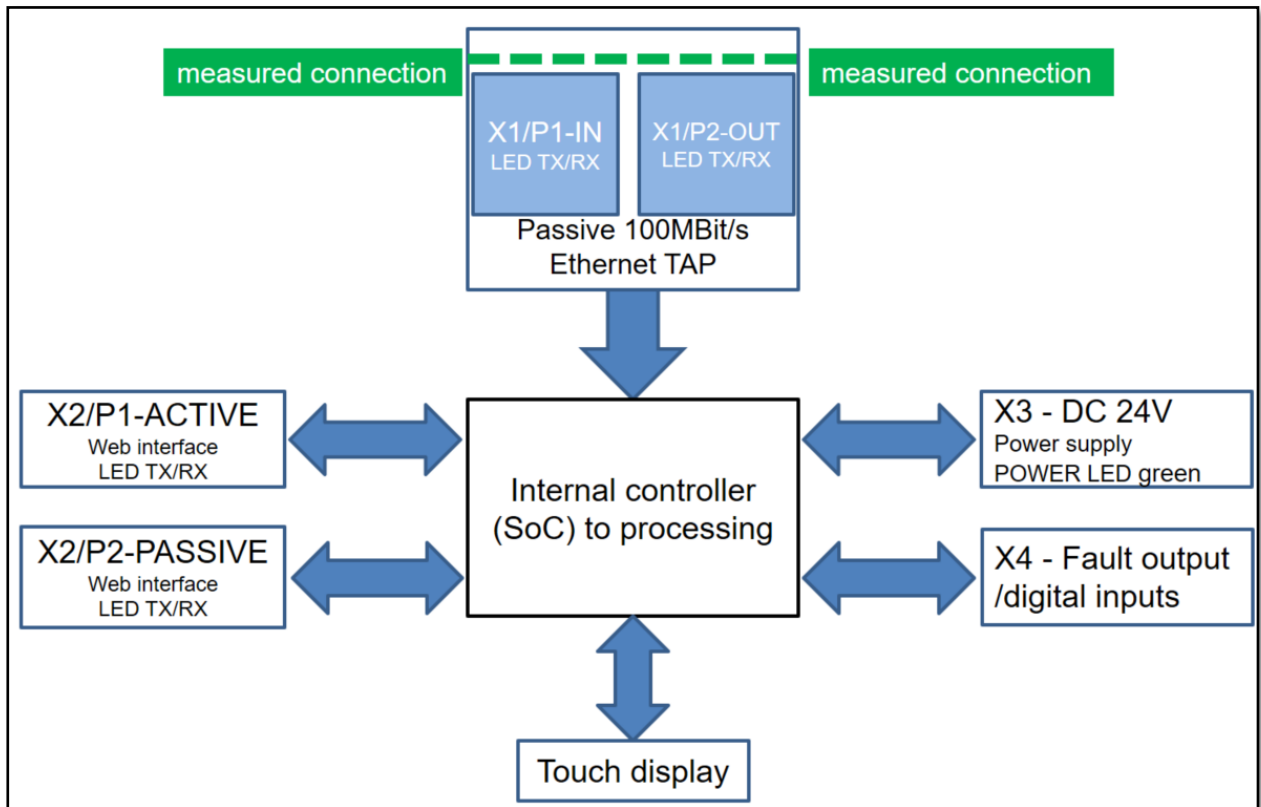

Figure 45: Block diagram

9 Technical data

- Voltage supply: +24V DC
- Tolerance: $\pm 10\%$
- Power consumption: Max. 200 mA
- Starting current: Max. 200 mA
- Dimensions (W x H x D): 105 x 125 x 132 (in mm)
- Assembly: TS35 DIN top-hat rail (EN 50022)
- Weight: 0.840 kg
- Protection class: IP20
- Operating temperature: +5 °C to +55 °C
- Storage temperature: -20 °C to +70 °C
- Relative air humidity: 10%...90%

9.1 Technical drawing

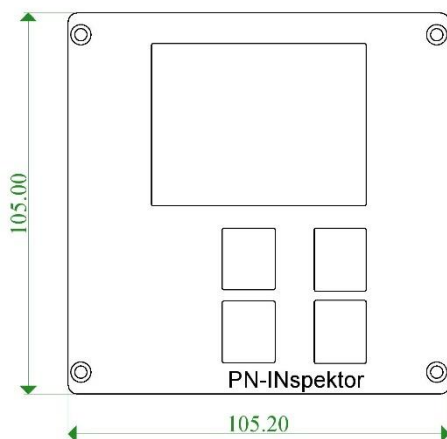

Figure 46: Front view

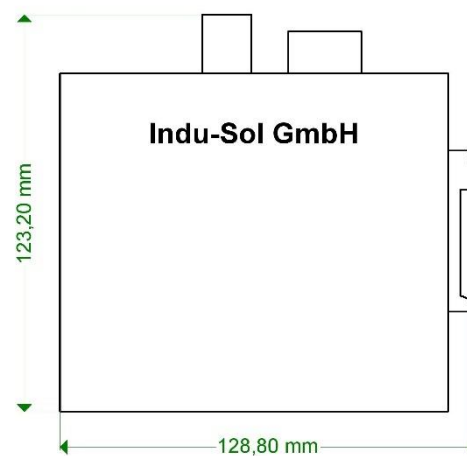

Figure 47: Side view with plugs and top-hat rail mounting

Indu-Sol GmbH
Blumenstrasse 3
04626 Schmoelln

Telephone: +49 (0) 34491 5818-0
Telefax: +49 (0) 34491 5818-99

info@indu-sol.com
www.indu-sol.com

We are certified according to DIN EN ISO 9001:2008